

The safe handling of a manual wheelchair

OPENING AND CLOSING A WHEELCHAIR OPENING



Opening

- Put the brakes on.
- Stand in front of the chair, maintain a good posture.
- Place hands flat on the sides of the seat canvas and push down and out, keep fingers pointing into the chair to avoid entrapment.
- Unfold the backrest and lock into place.

CLOSING

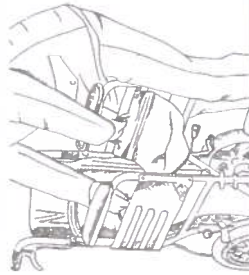

Closing

- Put the brakes on.
 - Unlock the backrest and fold down.
 - Flip the footrests up.
 - If there are handles on the seat canvas, grasp them firmly and pull them up towards you, maintain a good posture.
 - If there are no handles on the seat canvas, gently bend your hips and knees and take hold of the middle front and rear edges of the seat canvas and pull up as you straighten your hips and knees.
- ### GETTING IN AND OUT OF A WHEELCHAIR
- Align the front wheels to ensure large stable footprint of the chair.
 - Put the brakes on.

- Fold up the footrests and move the footrest mechanism around to the side of the wheelchair or remove footrest mechanism if not enough room.

GETTING IN

- Encourage the user to lower themselves slowly and push themselves back into the chair.
 - Replace the footrest mechanism and encourage the user to position their feet. If they require assistance, remember to adopt a good posture – **DO NOT STOOP**.
 - The lap strap should be fastened, it should be across the pelvis not around the waist (MHRA 2008). Encourage the user to do this. Again, if assistance is required, maintain a good posture.
- #### GETTING OUT
- Undo the lap strap.
 - Encourage the user to move forwards in the chair and push up into standing.
 - Replace the footrest mechanism and lock into place.

PUSHING A WHEELCHAIR PUSHING ON THE LEVEL



Pushing on a level

- Pre-check the route where possible, identify likely hazardous spots, alter the route if necessary.
- Stand close to the wheelchair, keeping your spine upright, with your elbows slightly bent, avoid stooping and overreaching.
- Keep your elbows soft to absorb stresses.
- Use the power in your legs as you walk forward to produce forward momentum.

- Where possible keep the wheelchair moving as it takes more effort to stop and start, but rest if required.
- To turn the wheelchair apply pressure to one handle and the wheelchair will turn, i.e. forward pressure on the right handle will turn the wheelchair to the **LEFT**. Pulling on the right handle will turn it to the **RIGHT**. **NB NEVER TURN A WHEELCHAIR BY LIFTING THE HANDLES.**
- Regularly stretch your back muscles.

PUSHING UPHILL

- Stay as upright as possible – **DO NOT STOOP**.
- Tall people may need to push from further away than shorter people.
- Try **not** to stick your bottom out. For really steep slopes adopt a position with hands forwards, elbows bent and head up and a straight line from your back foot to your head.

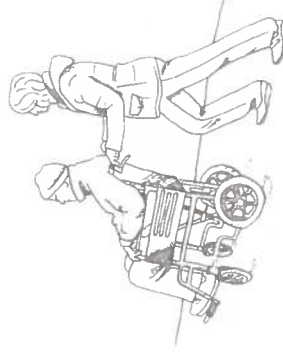

Pushing uphill

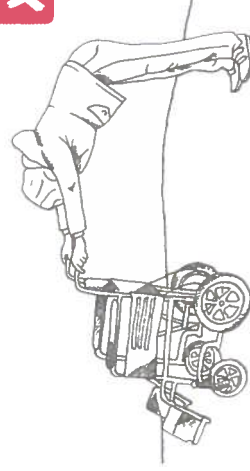

How not to push uphill

PUSHING DOWNHILL

- Remain close to the wheelchair.
- Use your leg muscles to counterbalance the wheelchair.
- Lean backwards.

- Use hand brakes, if fitted, to control speed.
- For short, steep inclines, it may be easier to go down backwards.

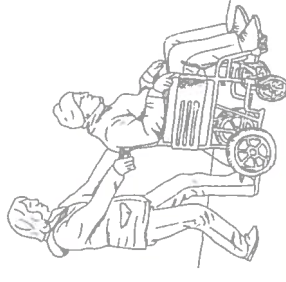

Pushing downhill

NEGOTIATING STEPS, KERBS AND DOORS STEPS AND KERBS

- Avoid steps and kerbs where possible – use ramps, slopes and dropped kerbs.
- Adhere to road safety awareness.

GOING UP A STEP/KERB



Going up

- Communicate with the wheelchair user throughout the manoeuvre.
- Ensure the lap strap is fastened.
- Slowly tip the wheelchair onto the rear wheels, using the tipper bar if available and by pushing down through the handles.
- Allow for enough clearance of the front wheels over the step/kerb, lower the front wheels and push steadily forward; using momentum, the rear wheels will ride up onto the surface/pavement.
- Do not attempt to turn the chair until all four wheels are in contact with the new surface.

GOING DOWN A STEP/KERB

- Communicate with the wheelchair user throughout the manoeuvre.
- Ensure the lap strap is fastened.
- Reverse the wheelchair to the edge of the step/kerb; be aware if the wheelchair user has spatial orientation problems.
- Pull the wheelchair towards you allowing the rear wheels to roll gently over the kerb and down, using your body weight as a counterbalance.
- Lower the front wheels onto the receiving surface.

DOORS

- Get assistance from another person, where possible, to hold the door open.
- Carry a door wedge in your pocket so if you are unable to keep the door open, you can wedge it. Remember to remove it after use.
- Avoid banging the footrest into the door to open it.
- Doors that push open: brace it with your body and reverse the wheelchair user through the doorway.
- Doors that pull open: open the door and brace it with your arm as you push the wheelchair user through.
- Ask the wheelchair user to tuck in their elbows to avoid injury.

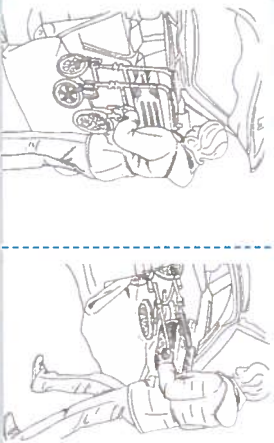

LOADING A WHEELCHAIR INTO A VEHICLE

Loading a wheelchair into a vehicle

- Plan the process.
- Ask for assistance if available.
- Remove cushions, footrests, armrests, rear wheels etc. if possible.
- Drop the backrest of the wheelchair.
- Fold the chair – see opening and closing a wheelchair.
- Use a blanket over the back of the boot sill to protect it from scratches.
- Hold the wheelchair by its frame.

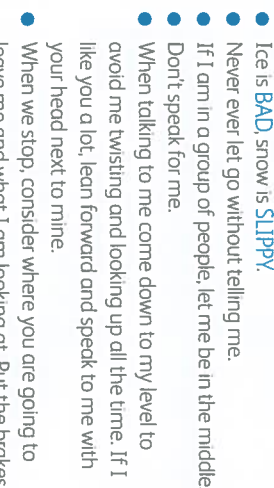

- Remember good posture and lifting principles; lift and place it on the edge of the boot opening.
- Pivot the wheelchair into the boot and secure.
- Reverse the procedure for removing.
- Bags and hoist are commercially available for lifting manual wheelchairs in and out of cars.

HOW TO PUSH A WHEELCHAIR

– USER'S PERSPECTIVE

- Ask me before you start to push.
- Understand that the wheelchair is an extension of my body.
- I am still in control even though you are pushing.
- Aim for a smooth ride; no sudden stops, starts or turns.
- Do not lean on the chair.
- Look where you are going avoid, glass, chewing gum, dog mess etc.
- Keep an eye out for raised paving slabs.
- Beware of other pavement users.
- No texting or answering your phone when you are pushing me.
- Steer away from cobblestones, uneven floors etc., the vibration can be very painful.
- Bumps are painful – **WARN ME**, then avoid them, steer round them or go more slowly.
- Avoid recently laid tarmac.
- Avoid puddles.
- Ice is **BAD**, snow is **SLIPPY**.
- Never ever let go without telling me.
- If I am in a group of people, let me be in the middle.
- Don't speak for me.
- When talking to me come down to my level to avoid me twisting and looking up all the time. If I like you a lot, lean forward and speak to me with your head next to mine.
- When we stop, consider where you are going to leave me and what I am looking at. Put the brakes on and check that I am happy.

FURTHER INFORMATION

- MHRA (2008). *All posture/safety belts fitted to seating, stair lifts, hoists and wheelchairs* (MDA/2008/037) www.msc-online.com/Objects/ViewObject.aspx?ID=OTA703 interactive learning tool
- www.wheelchairguide.net/manual-wheelchair-parts-diagram
- Copyright NBE 2014

The safe handling of a manual wheelchair

Author **Penny Townsend MCSP** NBE Registered Member in conjunction with the Yorkshire Back Exchange Local Group

ISBN 978-0-9564838-6-7

LEAFLET 002 APRIL 14



INTRODUCTION

Many carers use wheelchairs on a daily basis to assist in moving their clients. Knowing how to handle a wheelchair safely is therefore important for reducing the risks of injury to both the carer and wheelchair user. This leaflet summarises the important information that needs to be considered.

DO'S AND DON'TS OF USING A WHEELCHAIR

DO'S

- ✔ Check the wheelchair is in good working order and report any problems or defects immediately to wheelchair services.
- ✔ Consider whether you are dressed appropriately for pushing a wheelchair; wearing trousers and flat secure shoes offers greater stability and promotes better postures for movement.
- ✔ Ensure that the user's clothing, scarves, sling straps, oxygen tubing, feed tubes etc cannot become tangled on the wheels or hooked over the wheelchair armrests/framework.
- ✔ Ensure you know how to operate the brakes and that they are on when the wheelchair is not in motion.
- ✔ Adjust the height of the push handles where possible to prevent you stooping.
- ✔ Ensure you maintain a good posture – keep upright, pushing using the power of your legs, keep close to the wheelchair and don't twist.
- ✔ Do talk directly to the wheelchair user.

DON'TS

- ✘ Overload the back of the wheelchair with heavy bags; it alters the stability of the wheelchair.
- ✘ Add cushions or other accessories without assessment from a therapist.
- ✘ Stoop when making checks and adjustments to lap straps, footrests etc – use a step stand, kneel, squat position or sit on a chair or stool.
- ✘ Lean on the wheelchair.
- ✘ Take over the person's wheelchair and push them, if they don't require assistance.

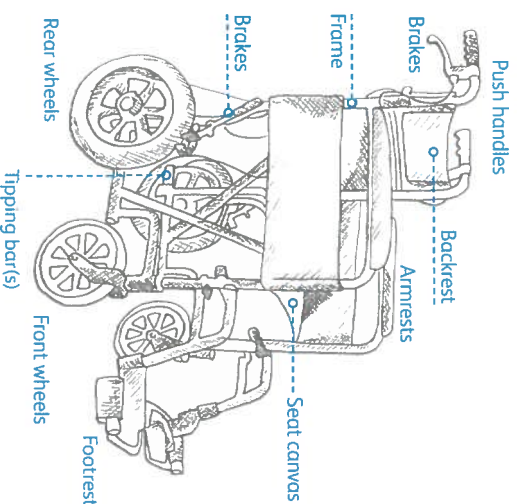

Manual wheelchair parts